

## **USER MANUAL**

**MAGNAVOX**  
SMART. VERY SMART.

*Color Television*

**13MT143S**

**20MT133S**

**20MS233S**

*Thank you for choosing Magnavox.*

*Need help fast?*



*Read your User Manual first for quick tips that make using your Magnavox product more enjoyable. If you have read your instructions and still need assistance you may access our online help at*

*[www.magnavox.com](http://www.magnavox.com)*

*or*

*call 1-800-705-2000*

*while with your product.*

IB8470E001

## Return your Warranty Registration card today to ensure you receive all the benefits you're entitled to.

Once your MAGNAVOX purchase is registered, you're eligible to receive all the privileges of owning a MAGNAVOX product. So complete and return the Warranty Registration Card enclosed with your purchase at once. And take advantage of these important benefits.

### Warranty Verification

Registering your product within 10 days confirms your right to maximum protection under the terms and conditions of your MAGNAVOX warranty.

### Owner Confirmation

Your completed Warranty Registration Card serves as verification of ownership in the event of product theft or loss.

### Model Registration

Returning your Warranty Registration Card right away guarantees you'll receive all the information and special offers which you qualify for as the owner of your model.

### Congratulations on your purchase, and welcome to the "family!"

#### Dear MAGNAVOX product owner:

Thank you for your confidence in MAGNAVOX. You've selected one of the best-built, best-backed products available today. We'll do everything in our power to keep you happy with your purchase for many years to come.

As a member of the MAGNAVOX "family," you're entitled to protection by one of the most comprehensive warranties and outstanding service networks in the industry. What's more, your purchase guarantees you'll receive all the information and special offers for which you qualify, plus easy access to accessories from our convenient home shopping network.

Most importantly, you can count on our uncompromising commitment to your total satisfaction.

All of this is our way of saying welcome—and thanks for investing in a MAGNAVOX product.

**P.S. Remember, to get the most from your MAGNAVOX product, you must return your Warranty Registration Card within 10 days. So please mail it to us right now!**

Know these **safety** symbols



**⚡** This "bolt of lightning" indicates uninsulated material within your unit may cause an electrical shock. For the safety of everyone in your household, please do not remove product covering.

**⚠** The "exclamation point" calls attention to features for which you should read the enclosed literature closely to prevent operating and maintenance problems.

**WARNING:** To reduce the risk of fire or electric shock, this apparatus should not be exposed to rain or moisture and objects filled with liquids, such as vases, should not be placed on this apparatus.

**CAUTION:** To prevent electric shock, match wide blade of plug to wide slot, fully insert.

**ATTENTION:** Pour éviter les choc électriques, introduire la lame la plus large de la fiche dans la borne correspondante de la prise et pousser jusqu'au fond.

#### For Customer Use

Enter below the Serial No. which is located on the rear of the cabinet. Retain this information for future reference.

Model No. \_\_\_\_\_  
Serial No. \_\_\_\_\_

Visit our World Wide Web Site at <http://www.magnavox.com>

# IMPORTANT SAFETY INSTRUCTIONS

## Read before operating equipment

1. Read these instructions.
2. Keep these instructions.
3. Heed all warnings.
4. Follow all instructions.
5. Do not use this apparatus near water.
6. Clean only with a dry cloth.
7. Do not block any of the ventilation openings. Install in accordance with the manufacturers instructions.
8. Do not install near any heat sources such as radiators, heat registers, stoves, or other apparatus (including amplifiers) that produce heat.
9. Do not defeat the safety purpose of the polarized or grounding-type plug. A polarized plug has two blades with one wider than the other. A grounding type plug has two blades and third grounding prong. The wide blade or third prong are provided for your safety. When the provided plug does not fit into your outlet, consult an electrician for replacement of the obsolete outlet.
10. Protect the power cord from being walked on or pinched particularly at plugs, convenience receptacles, and the point where they exit from the apparatus.
11. Only use attachments/accessories specified by the manufacturer.
12.  Use only with a cart, stand, tripod, bracket, or table specified by the manufacturer, or sold with the apparatus. When a cart is used, use caution when moving the cart/apparatus combination to avoid injury from tip-over.
13. Unplug this apparatus during lightning storms or when unused for long periods of time.
14. Refer all servicing to qualified service personnel. Servicing is required when the apparatus has been damaged in any way, such as power-supply cord or plug is damaged, liquid has been spilled or objects have fallen into apparatus, the apparatus has been exposed to rain or moisture, does not operate normally, or has been dropped.
15. This product may contain lead and mercury. Disposal of these materials may be regulated due to environmental considerations. For disposal or recycling information, please contact your local authorities or the Electronic Industries Alliance: [www.eiae.org](http://www.eiae.org)
16. **Damage Requiring Service** - The appliance should be serviced by qualified service personnel when:
  - A. The power supply cord or the plug has been damaged; or
  - B. Objects have fallen, or liquid has been spilled into the appliance; or
  - C. The appliance has been exposed to rain; or
  - D. The appliance does not appear to operate normally or exhibits a marked change in performance; or
  - E. The appliance has been dropped, or the enclosure damaged.
17. **Tilt/Stability** - All televisions must comply with recommended international global safety standards for tilt and stability properties of its cabinet design.
  - Do not compromise these design standards by applying excessive pull force to the front, or top, of the cabinet which could ultimately overturn the product.
  - Also, do not endanger yourself, or children, by placing electronic equipment/toys on the top of the cabinet. Such items could unsuspectingly fall from the top of the set and cause product damage and/or personal injury.
18. **Wall or Ceiling Mounting** - The appliance should be mounted to a wall or ceiling only as recommended by the manufacturer.
19. **Power Lines** - An outdoor antenna should be located away from power lines.
20. **Outdoor Antenna Grounding** - If an outside antenna is connected to the receiver, be sure the antenna system is grounded so as to provide some protection against voltage surges and built up static charges.  
Section 810 of the National Electric Code, ANSI/NFPA No. 70-1984, provides information with respect to proper grounding of the mast and supporting structure, grounding of the lead-in wire to an antenna discharge unit, size of grounding connectors, location of antenna-discharge unit, connection to grounding electrodes, and requirements for the grounding electrode. See Figure below.
21. **Object and Liquid Entry** - Care should be taken so that objects do not fall and liquids are not spilled into the enclosure through openings. comply with recommended international global safety standards for tilt and stability properties of its cabinet design.
22. **Battery Usage CAUTION** - To prevent battery leakage that may result in bodily injury, property damage, or damage to the unit
  - Install all batteries correctly, with + and - aligned as marked on the unit.
  - Do not mix batteries (old and new or carbon and alkaline, etc.).
  - Remove batteries when the unit is not used for a long time.

**Note to the CATV system installer:** This reminder is provided to call the CATV system installer's attention to Article 820-40 of the NEC that provides guidelines for proper grounding and, in particular, specifies that the cable ground shall be connected to the grounding system of the building, as close to the point of cable entry as practical.

**Example of Antenna Grounding as per NEC - National Electric Code**

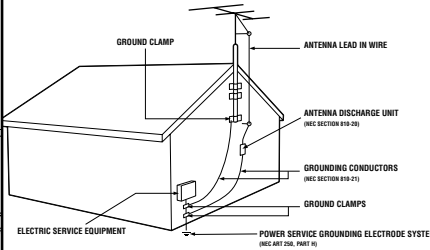

## PANEL LAYOUT

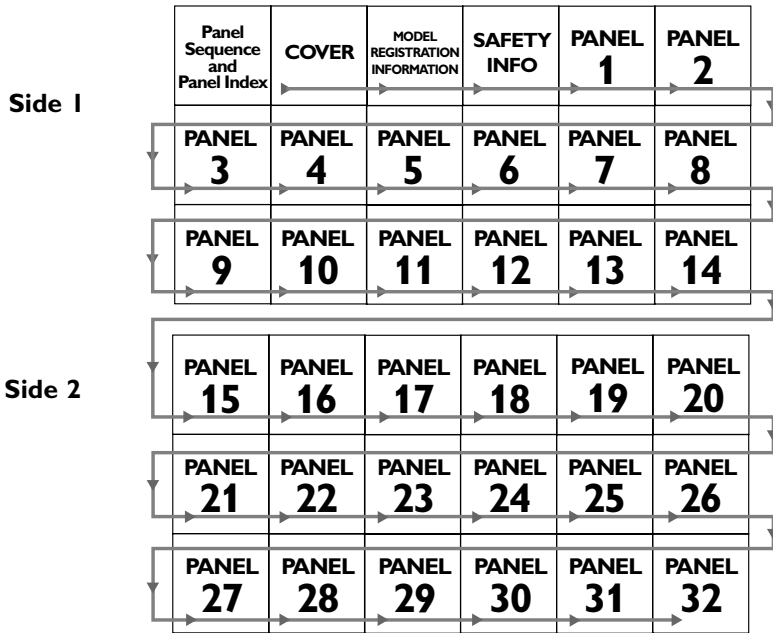

## PANEL INDEX

Subject	Panel No.	Subject	Panel No.
Alternate Channel	26	Picture Menu Controls	11
Antenna Basic Connection	1	Remote Batteries	4
Front Audio/Video Input Jacks	3	Remote Control Button Descriptions	5-6
Automatically Program TV	9	Sleeptimer	22
Basic Cable Connection	1	SmartLock™ Controls	
Basic Remote Operation	4	Access Code	15
Basic Television Operation	4	Block Channels	16
Cable Box Connection	1-2	Blocking/Clearing All Channels	17
Cable TV Control (Tuner Mode)	8	Movie Ratings	18
Care and Cleaning	28	Other Blocking Options	20
Channel Edit	10	TV Ratings	19
Closed Caption Control	21	Understanding SmartLock™	14
Format Control	13	SmartPicture™ Control	23
Glossary	29	SmartSound™ Control	24
Language Control	7	SmartSurf	25
Limited Warranty	32	Troubleshooting	27

SmartPicture™, SmartSound™, and SmartLock™ are registered trademarks of Philips Consumer Electronics North America. Copyright © 2003 Magnavox. All rights reserved.

# I

## Basic Antenna Connection

A combination antenna receives normal broadcast channels (VHF 2-13 and UHF 14-69). Your connection is easy since there is only one 75Ω (ohm) antenna plug on the back of your TV - and that's where the antenna goes.

**1** If your antenna has a round cable (75 ohm) on the end, then you're ready to connect it to the TV. Go to step 2.

If your antenna has flat twin-lead wire (300 ohm), you first need to attach the antenna wires to the screws on a 300 to 75 ohm adapter (not supplied with TV).

**2** Push the round end of the adapter or antenna cable onto the 75Ω jack on the rear of the TV. If the round end of the antenna cable is threaded, screw it down tight.

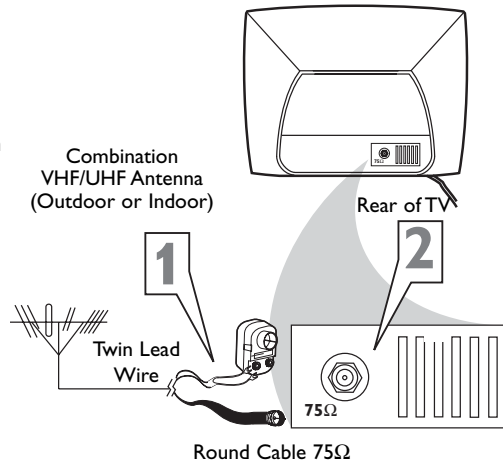

## Basic Cable TV Connection

If Cable TV signal into your home is a single cable (75 ohm) the connection to the TV is easy.

**1** Connect the Cable TV cable directly to the 75Ω jack on the TV.

### Helpful Hints

If no Video Signal is present, the TV will shut itself off in about 10 minutes. If the TV is tuned to the AV channel and there is no Video Signal present, the screen will remain black and the TV will shut itself off in about 10 minutes.

Use Auto Program as described on panel 9 to set up channels that are available in your area. Use the CH +/- buttons to scan available channels.

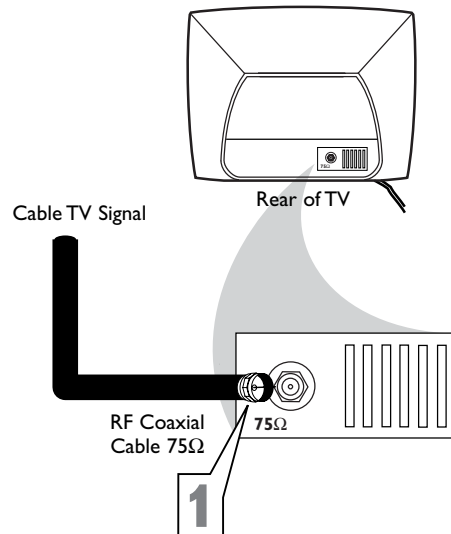

## 2

## Cable Box Connections

If your cable signal uses a cable box or decoder, follow the easy steps below to complete the connection.

### Cable Box (w/RF In/Outputs):

This connection will be mono.

- 1** Connect the Cable Company supplied cable to the signal IN(put) plug on the back of the Cable Box.
- 2** Using a separate round coaxial cable, connect one end to the OUT(put) (TO TV) plug on the back of the Cable Box.
- 3** Connect the other end of the round coaxial cable to the 75Ω input on the back of the television. Screw it down finger tight.

**NOTE:** If applicable, set the OUTPUT CHANNEL SWITCH on the back of the cable box to CH 3 or 4. Tune the TV to the same channel and change channels at the cable box. In some cases, the cable box will automatically tune to either channel 3 or 4, change channels until the picture appears.

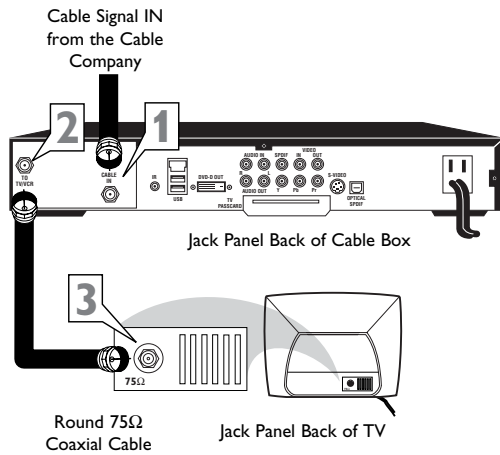

### Helpful Hints

If no Video Signal is present, the TV will shut itself off in about 10 minutes. If the TV is tuned to the AV channel and there is no Video Signal present, the screen will remain black and the TV will shut itself off in about 10 minutes.

### 3 Front AV (Audio/Video) Input Connections

Audio and Video Front Inputs are available for a quick connection of a VCR, to playback video from a camera, or attach a gaming device. Use the AV button on the remote control to tune these inputs.

**1** Connect the video (yellow) cable from the Video output on the Camera (or accessory device) to the Video (yellow) Input located on the FRONT of the TV.

**2** For Mono Devices: Connect one end of the audio cable from the Audio Out jack on the device to the Audio In (white) jack on the FRONT of the television.

For Stereo Devices: Connect one end of the audio cables from the Audio Out jacks on the device to the Audio In (red and white) jacks on the FRONT of the television.

**3** Turn the TV and the accessory device ON.

**4** Press the CH+ or CH- button on the remote control to tune the TV to the front input jacks. "AV" will appear on the TV screen.

**5** Press the PLAY button on the accessory device to view playback, or to access the accessory device (camera, gaming unit, etc.).

#### Mono Devices

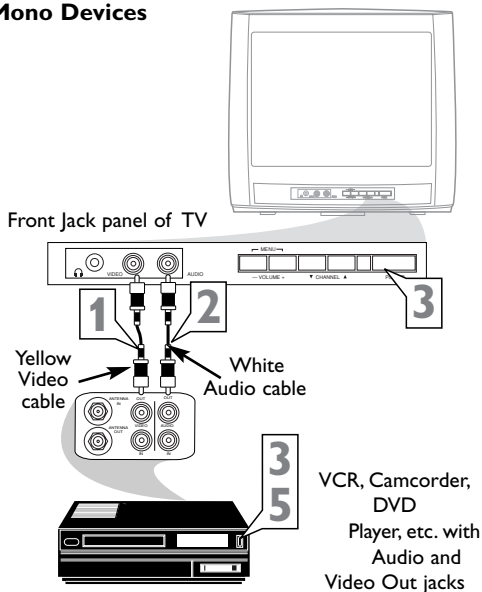

#### Stereo Devices:

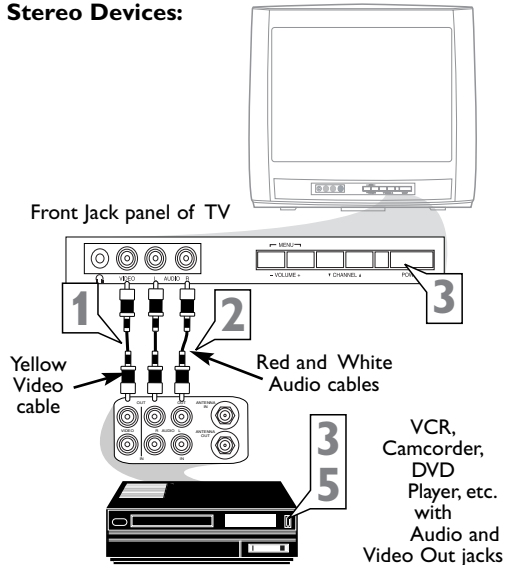

# 4 Basic TV and Remote Control Illustrations

## Television

- 1 Press **POWER** to turn on the TV.
- 2 Press **VOLUME +** to increase the sound level. Press **VOLUME -** to lower the sound level. Press both buttons at the same time to display the TV's on-screen menu. Once in the menu, use these buttons to make menu adjustments or selections.
- 3 Press **CHANNEL ▲** or **▼** to select TV channels.

## Remote Control

- 4 Point the remote control toward the remote sensor on the front of the TV when operating the TV.

## Battery Installation

To load the supplied batteries into the remote:

- 1 Remove the battery compartment lid on the back of the remote.
- 2 Place the batteries (two AA) in the remote. Be sure the (+) and (-) ends of the batteries line up correctly (as marked inside the remote).
- 3 Reattach the battery lid.

## Helpful Hints

The current channel number will appear briefly when you first turn on the TV or when you change channels. Press STATUS/EXIT to see the current channel number.

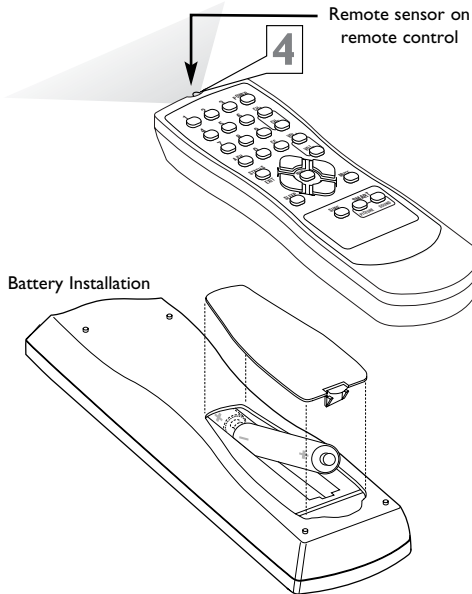
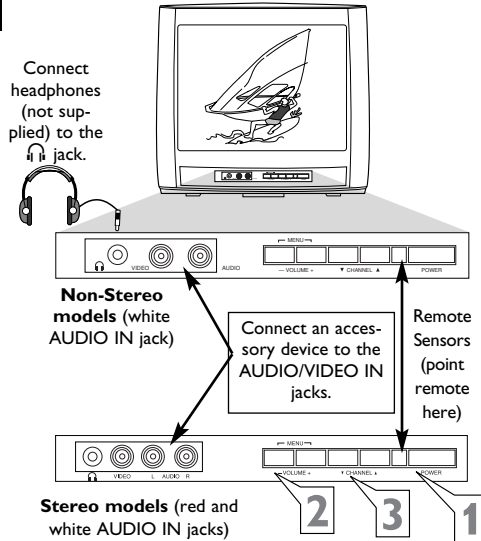



**NUMBER Buttons**

Press the Number buttons to select TV channels or to enter values in the menu. For single-digit channels, press the Number button for the channel you want. The TV will pause briefly before going to the chosen channel.

**A/CH Button  
(Alternate Channel)**

Press to switch between the last channel and the present channel.  
*Details are on panel 26.*

**STATUS/EXIT Button**

Press to see the current channel number.  
Press to remove a menu.

**CC Button**

Press to activate Closed Captioning.  
*Details are on panel 21.*

**SLEEP Button**

Press to set the TV to turn itself off within a certain time. *Details are on panel 22.*

**SmartSurf**

If your TV model has SmartSurf, press this button to move through the channels you have set. *Details are on panel 25.*

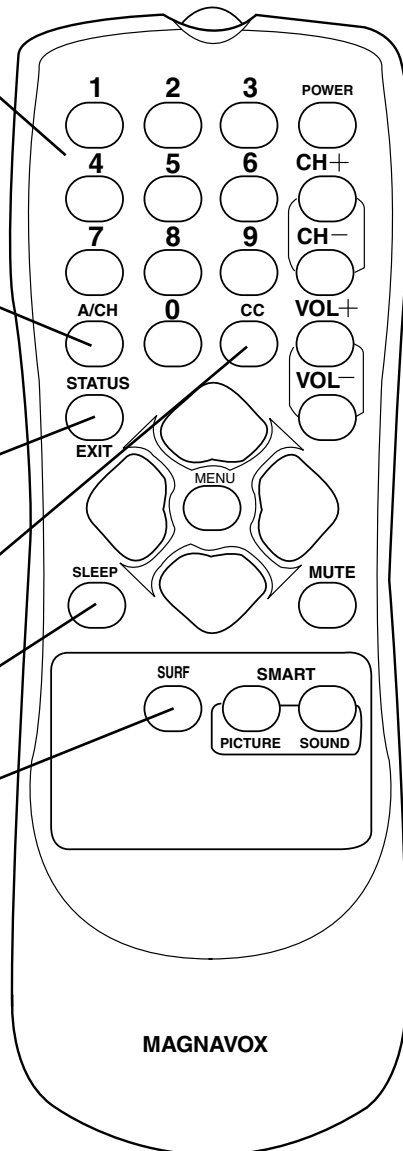

Continued on Next Panel

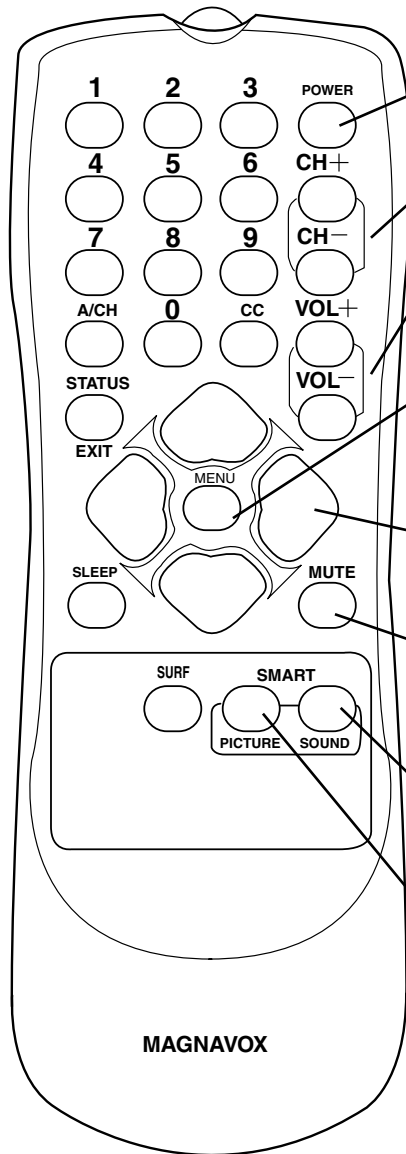
**POWER button**

Press to turn the TV on or off.

**CH(annel) +/- Buttons**

Press to scan memorized channels.

**VOL(ume) +/- Buttons**

Press to increase or decrease the sound.

**MENU Button**

Press to see the menu. Press repeatedly to return to previous menus or remove the menus.

**Arrow ◀ ▶ ▲ ▼ Buttons**

Press to select or adjust items in the menu.

**MUTE Button**

Press to eliminate or restore the TV sound. MUTE will appear on the TV when the sound is muted.

**SMART SOUND Button**

Press to choose a sound setting.  
*Details are on panel 24.*

**SMART PICTURE Button**

Press to choose a picture setting.  
*Details are on panel 23.*

MAGNAVOX

For our Spanish speaking TV owners an on-screen LANGUAGE option is present. With the LANGUAGE control you can set the TV's on-screen menu to be shown in either English or Spanish.

- 1 Press the **MENU** button on the remote to show the on-screen menu.
- 2 Press the **CURSOR UP ▲** or **DOWN ▼** buttons to scroll through the on-screen menu until the word **INSTALL** is highlighted.
- 3 Press the **CURSOR RIGHT ►** button to display the **INSTALL** menu features.
- 4 Press **CURSOR UP ▲** or **DOWN ▼** buttons to scroll the Install features until the word **LANGUAGE** is highlighted.
- 5 Press the **CURSOR RIGHT ►** button repeatedly to select **ENGLISH** or **ESPAÑOL** (Spanish).
- 6 When finished, press the **STATUS /EXIT** button to remove the menu from the TV's screen.

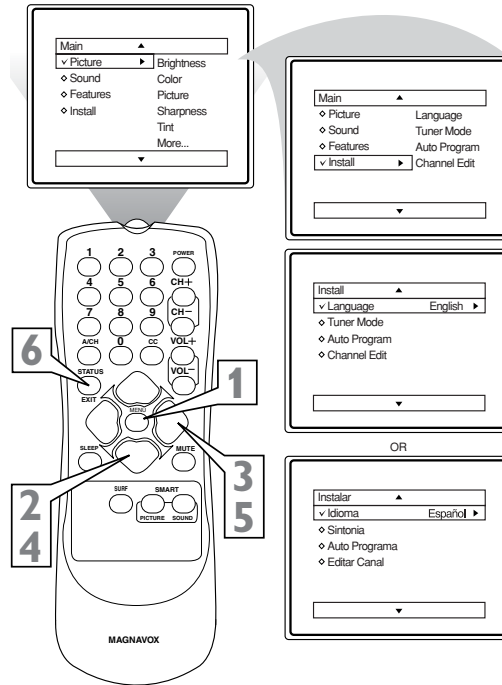

### HELPFUL HINT

The Language control only makes the TV's on-screen MENU items appear in English or Spanish text. It does not change the other on-screen text features such as Closed Caption (CC) TV shows.

The **TUNER MODE** control allows you to change the TV's signal input to either **ANTENNA**, **CABLE**, or **AUTO** mode. It's important for the TV to know what type of signal that is connected. (From a Cable TV signal or a normal Antenna signal.) In the **AUTO** mode, when the **AUTO PROGRAM** feature is activated, the TV will automatically choose the correct mode.

- 1** Press the **MENU** button on the remote to show the on-screen menu.
- 2** Press the **CURSOR UP ▲** or **DOWN ▼** buttons to scroll through the on-screen menu until the word **INSTALL** is highlighted.
- 3** Press the **CURSOR RIGHT ►** button to display the **INSTALL** menu features.
- 4** Press **CURSOR UP ▲** or **DOWN ▼** buttons to scroll the Install features until the words **TUNER MODE** is highlighted.
- 5** Press the **CURSOR RIGHT ►** button to select either **ANTENNA**, **CABLE**, or **AUTO** mode.
- 6** When finished, press the **STATUS /EXIT** button to remove the on-screen menu from the TV's screen.

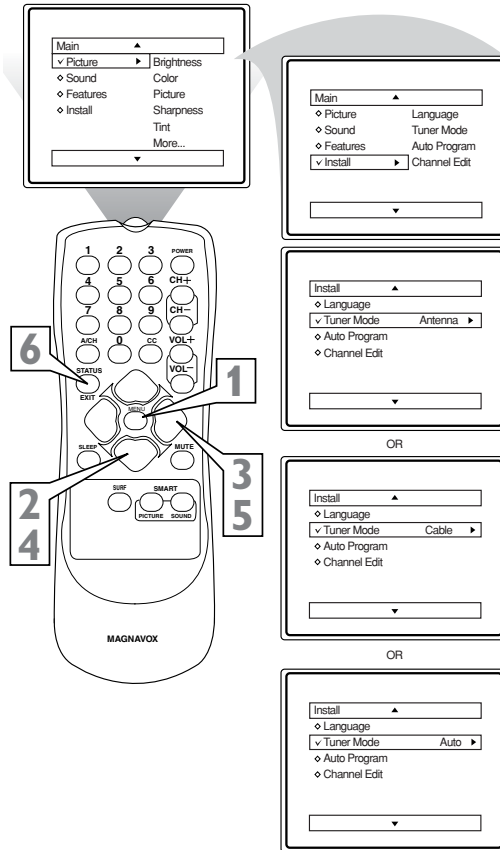

Your TV can automatically set itself for local area (or Cable TV) channels. This makes it easy for you to select only the TV stations in your area when the CHANNEL (+) or (-) buttons are pressed.

Note: Make sure the antenna or cable signal connection has been completed before AUTO PROGRAM is activated.

- 1** Press the **MENU** button on the remote to show the on-screen menu.
- 2** Press the **CURSOR UP ▲** or **DOWN ▼** buttons to scroll through the on-screen menu until the word **INSTALL** is highlighted.
- 3** Press the **CURSOR RIGHT ►** button to display the **INSTALL** menu features.
- 4** Press **CURSOR UP ▲** or **DOWN ▼** buttons to scroll the Install features until the words **AUTO PROGRAM** are highlighted.
- 5** Press the **CURSOR RIGHT ►** button to start the Auto Program scanning of channels. Auto Programming will store all available channels in the TV's memory then tune to the lowest available channel when done.
- 6** When finished, press the **STATUS/EXIT** button to remove the menu from the TV's screen.

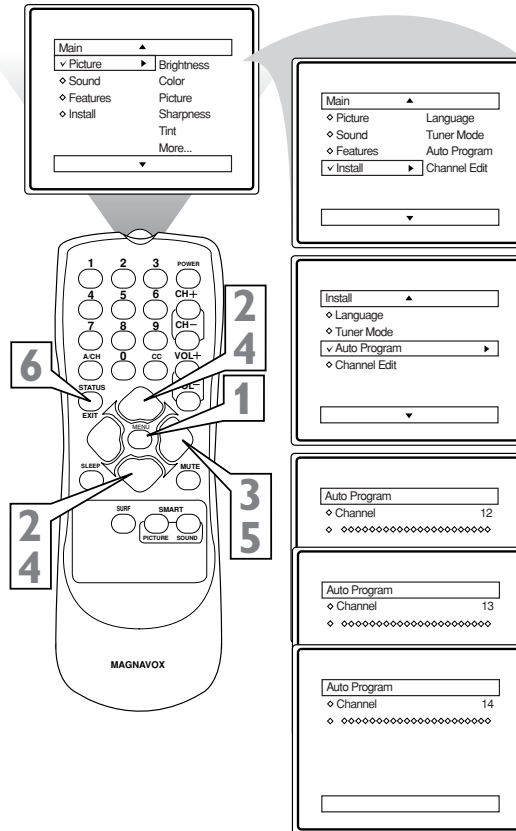

## HELPFUL HINT

When CABLE is selected, channels 1-125 are available.

When ANTENNA is selected, channels 2-69 are available.

When AUTO is selected, the TV will automatically set itself to the correct mode based on the type of signal it detects when the AUTO PROGRAM feature is activated.

*Channel Edit makes it easy for you to ADD or DELETE channels from the list of channels stored in the TV's memory.*

- 1** Press the **MENU** button on the remote to show the on-screen menu.
- 2** Press the **CURSOR UP ▲** or **DOWN ▼** buttons to scroll through the on-screen menu until the word **INSTALL** is highlighted.
- 3** Press the **CURSOR RIGHT ►** button to display the **INSTALL** menu features.
- 4** Press the **CURSOR UP ▲** or **DOWN ▼** buttons to scroll the Install features until the words **CHANNEL EDIT** are highlighted.
- 5** Press the **CURSOR RIGHT ►** button to display the **CHANNEL EDIT** options.
- 6** With the **CHANNEL EDIT** options displayed, and **CHANNEL NO.** highlighted; you can use the cursor buttons to scroll through all available channels that you wish to add (Skipped OFF), or delete (Skipped ON) from the TV's memory. You can also use the **NUMBERED** buttons to go directly to a specific numbered channel that you wish to add or skip. Or, you can also use the **CH +** or **CH -** to quickly scan the channels that have not been skipped.
- 7** Using the **CURSOR DOWN ▼** button, scroll the menu to highlight the word **SKIPPED**.
- 8** Now use the **CURSOR RIGHT ►** button to toggle between **ON** or **OFF**.  
If **ON** is selected the channel is skipped when scrolling channels with the **CH +** or **-** buttons. If **OFF** is selected the channel is not skipped when scrolling channels with the **CH +** or **-** buttons.
- 9** When finished, press the **STATUS /EXIT** button to remove the menu from the TV's screen.

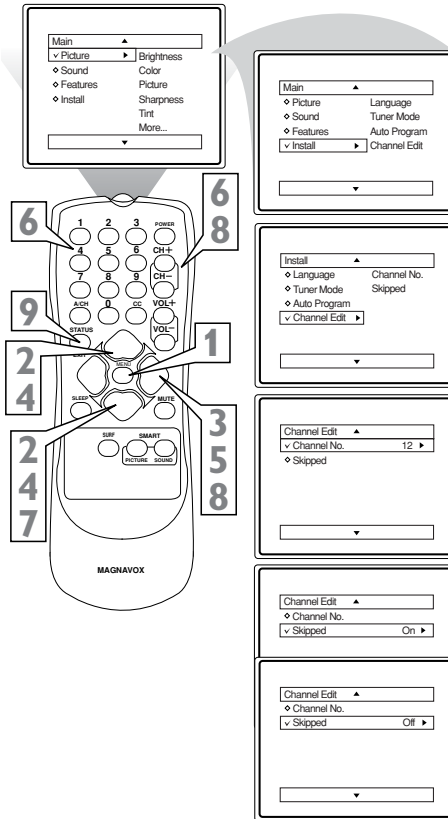

### HELPFUL HINT

An "X" appearing in front of any channel will indicate that channel has skip on. When the **CH +** or **CH -** buttons are used, those channels will be skipped.  
In order to get to the external input channel AV, you must use the **CURSOR Right ►** or **CURSOR LEFT ◀** buttons.

# II

## HOW TO USE THE PICTURE ADJUSTMENT CONTROLS

To adjust your TV picture controls, select a channel and use the Picture Menu Controls listed below:

- 1 Brightness:** Press the **CURSOR RIGHT ►** or **LEFT ◀** buttons until the darkest parts of the picture are as bright as you prefer.
- 2 Color:** Press the **CURSOR RIGHT ►** or **LEFT ◀** buttons to add or eliminate color.
- 3 Picture:** Press the **CURSOR RIGHT ►** or **LEFT ◀** buttons until lightest parts of the picture show good detail.
- 4 Sharpness:** Press the **CURSOR RIGHT ►** or **LEFT ◀** buttons to improve detail in the picture.
- 5 Tint:** Press the **CURSOR RIGHT ►** or **LEFT ◀** buttons to obtain natural skin tones.
- 6 Color Temp:** Press the **CURSOR RIGHT ►** or **LEFT ◀** buttons to select **NORMAL**, **COOL**, or **WARM** picture preferences. (**NORMAL** will keep the whites, white; **COOL** will make the whites, bluish; and **WARM** will make the whites, reddish.)
- 7 Contrast +:** Press the **CURSOR RIGHT ►** or **LEFT ◀** buttons to toggle the control **On** or **OFF**. The **Contrast +** control helps to “sharpen” the picture quality. The black portions of the picture become richer in darkness and the whites become brighter.

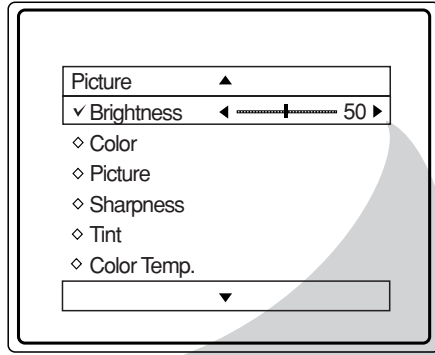

✓ Brightness	◀ ————  ————▶	65
✓ Color	◀ ————  ————▶	50
✓ Picture	◀ ————  ————▶	50
✓ Sharpness	◀ ————  ————▶	50
✓ Tint	◀ ————  ————▶	0
✓ Color Temp.		Normal
		Warm or Cool
✓ Contrast +		On
		Off

## 12 HOW TO USE THE SOUND CONTROLS (20MS233S ONLY)

To adjust your TV sound, select and use the Sound Menu Controls listed below.

**1 Treble Boost:** Press the ► or ◀ buttons to turn the control On or Off. When On, the control will enhance the high frequency sounds.

**2 Bass Boost:** Press the ► or ◀ buttons to turn the control On or Off. When On, the control will enhance the low frequency sounds.

**3 Balance:** Press the ► or ◀ buttons to adjust the level of sound coming from the left and right speakers.

**4 AVL:** (Auto Volume Leveler) Press the ► or ◀ buttons to turn the control On or Off. When On, AVL will level out the sound being heard when sudden changes in volume occur during commercial breaks or channel changes.

**5 Sound:** Press the ► or ◀ buttons to select between Stereo or Mono settings. Note: If Stereo is not present on a selected show and the TV is placed in the Stereo mode, the sound coming from the TV will remain in the Mono mode.

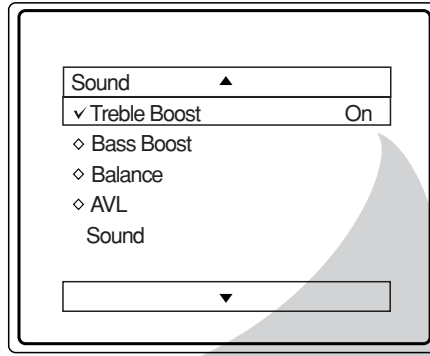

✓ Treble Boost	On
	or Off
✓ Bass Boost	On
	or Off
✓ Balance	◀ L ———+——— R ▶
✓ AVL	On
	or Off
✓ Sound	Mono
	or Stereo

**NOTE:** These sound options are only available in model 20MS233S. They are not available in 13MT143S or 20MT133S.



Many times while watching movies from a DVD player the image is shown in "letter box" format. This is the format that is shown in movie theaters. When shown on a TV screen, the image will have areas of black on top and bottom of the screen.

- 1 Press the **MENU** button on the remote to display the on-screen menu.
- 2 Press the **CURSOR DOWN ▼** button until the word **FEA-TURES** is highlighted.
- 3 Press the **CURSOR RIGHT ►** button to display the **FEATURES** menu options (SmartLock or Format).
- 4 Press the **CURSOR DOWN ▼** button until the word **FORMAT** is highlighted.
- 5 Press the **CURSOR RIGHT ►** or **CURSOR LEFT ◀** buttons to select one of the two options 4:3 or Expand 4:3.
  - 4:3 - Standard format for the TV.
  - Expand 4:3 - Enlarges the picture to fill out the entire screen area, eliminating the "letter box" effect.
- 6 When finished, press the **STATUS/EXIT** button to remove the menu from the TV's screen.

**Note:** The Expand 4:3 format can also be activated using the **CURSOR UP ▲** or **DOWN ▼** buttons when the onscreen menu is not being displayed. Pressing these buttons will toggle the standard 4:3 format and the Expand 4:3 format.

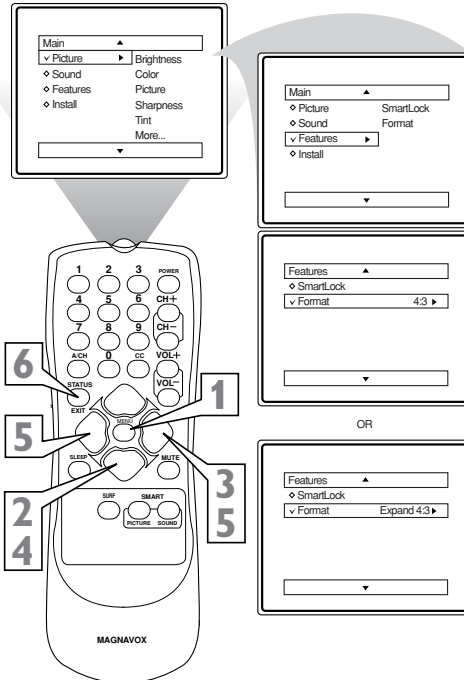

4:3



Expand 4:3

Some models refer to SmartLock as AutoLock in the on-screen menu. These features are the same.

The SmartLock™ feature is an integrated circuit that receives and processes data sent by broadcasters, or other program providers, that contain program content advisories. When programmed by the viewer, a TV with SmartLock™ can respond to the content advisories and block program content that may be found objectionable (such as offensive language, violence, sexual situations, etc.). This is a great feature to censor the type of viewing children may watch.

#### **SmartLock™ offers various BLOCKING controls from which to choose:**

**Access Code** - An Access Code must be set to prevent children from unblocking questionable or censored programming set by their parents.

**Channel Block** - After an access code has been programmed, you can block individual channels including the A/V inputs.

**Clear All** - Allows you clear all channels being blocked from your viewing set with the Channel Block Control.

**Block All** - Allows you to block ALL channels and A/V inputs at one time.

**Movie Ratings** - Certain blocking options exist which will block programming based on ratings patterned by the Motion Pictures Association of America.

**TV Ratings** - Just like the Movie Ratings, programs can be blocked from viewing using standard TV ratings set by TV broadcasters.

#### **MOVIE RATINGS**

**G: General Audience** - All ages admitted. Most parents would find this program suitable for all ages.

**PG: Parental Guidance Suggested** - This programming contains material that parents may find unsuitable for younger children.

**PG-13: Parents Strongly Cautioned** - This programming contains material that parents may find unsuitable for children under the age of 13.

#### **MOVIE RATINGS Continued**

**R: Restricted** - This is programming is specifically designed for adults. Anyone under the age of 17 should only view this programming with an accompanying parent or adult guardian.

**NC-17: No one under the age of 17 will be admitted.** - This type of programming should be viewed by adults only.

**X: Adults Only** - This type of programming contains one or more of the following: very graphic violence, very graphic and explicit or indecent sexual acts, very coarse and intensely suggestive language.

#### **TV RATINGS**

**TV-Y** -- Designed for a very young audience, including children ages 2-6.

**TV-Y7** -- It may be appropriate for children age 7 and above who have acquired the development skills needed to distinguish between make-believe and reality.

**TV-G** -- Suitable for most audiences, this type of programming contains little or no violence, no strong language, and little or no sexual dialogue or situations.

**TV-PG** -- This program contains material that parents may find unsuitable for younger children. Could contain Moderate violence (V), some sexual situations (S), infrequent coarse language (L), or some suggestive dialogue (D).

**TV-14** -- This program contains some material that many parents would find unsuitable for children under 14 years of age. This type of programming contains one or more of the following: intense violence (V), intense sexual situations (S), strong coarse language (L), or intensely suggestive dialogue (D).

**TV-MA** -- This program is specifically designed to be viewed by adults and therefore may be unsuitable for children under 17. This type of programming contains one or more of the following: graphic violence (V), explicit sexual situations (S), or crude indecent language (L).

Over the next few panels you'll learn how to block channels and get a better understanding of the rating terms for certain programming.

First, let's start by learning how to set a personal access code:

- 1 Press the **MENU** button on the remote to show the on-screen menu.
- 2 Press the **CURSOR UP ▲** or **DOWN ▼** buttons until the word **FEATURES** is highlighted.
- 3 Press the **CURSOR RIGHT ►** button to display the **FEATURES** menu options.
- 4 Press the **CURSOR UP ▲** or **DOWN ▼** buttons until the words **SmartLock™** are highlighted.
- 5 Press the **CURSOR RIGHT ►** button. The screen will read, "ACCESS CODE - - - -."
- 6 Using the **NUMBERED** buttons, enter **0, 7, 1, 1**. "XXXX" appears on the Access Code screen as you press the numbered buttons. "INCORRECT CODE" will appear on the screen, and you will need to enter **0, 7, 1, 1** again.
- 7 The screen will ask you to enter a "New Code." Enter a "new" **4** digit code using the **NUMBERED** buttons. The screen will then ask you to **CONFIRM** the code you just entered. Enter your new code again. "XXXX" will appear when you enter your new code and then display the **SmartLock™** menu options.

Proceed to the next panel to learn more...

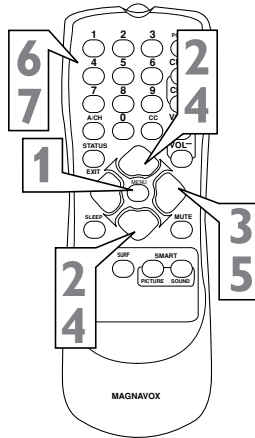
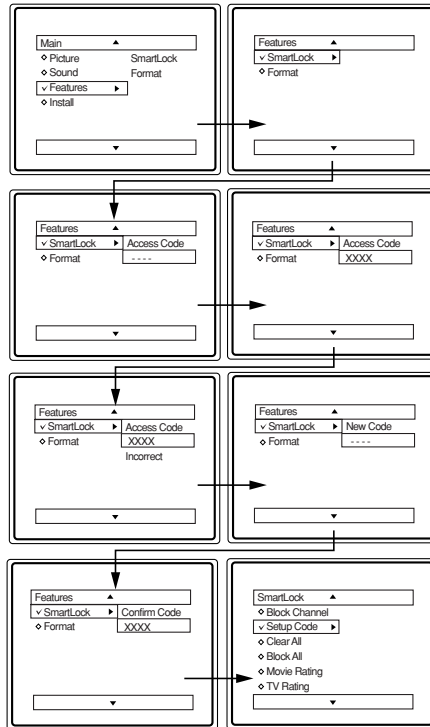

Some models refer to SmartLock as AutoLock in the on-screen menu. These features are the same.

After your personal access code has been set (see previous page), you are now ready to select the channels or the A/V Inputs you want to block out or censor. Once you've entered your access code and the SmartLock™ features are displayed on the screen:

- 1** Press the **CURSOR UP ▲** or **DOWN ▼** buttons until the words **BLOCK CHANNELS** are highlighted.
- 2** Press the **CURSOR RIGHT ►** button to turn blocking ON or OFF for that channel. When ON is selected the channel will be blocked.
- 3** Press the **CH +** or **CH -** button to select other channels you wish to block. Repeat step 2 to block the new channel.
- 4** When finished, press the **STATUS/EXIT** button to remove the menu from the screen.

**NOTE:** If you ever forget your code, the 0, 7, 1, 1 code is the factory default and can be used to enter and create a new access code.

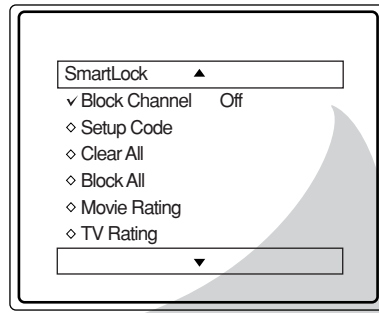

✓ Block Channel On

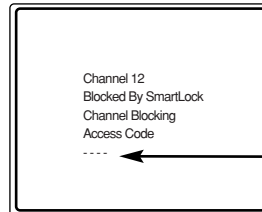

Enter your Access Code to view a tuned channel that is blocked with Block Channel.

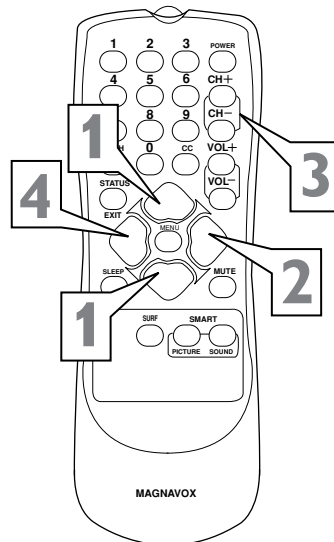

Some models refer to SmartLock as AutoLock in the on-screen menu. These features are the same.

After blocking specific channels there may come a time when you want to block or clear all the channels at the same time.

Once you've entered your access code and the SmartLock™ features are displayed on the screen:

**1** Press the **CURSOR UP ▲** or **DOWN ▼** buttons to select either **CLEAR ALL** or **BLOCK ALL**.

**2** If **CLEAR ALL** is selected, press the **CURSOR RIGHT ►** button to clear all blocked channels. All channels will be viewable.

If **BLOCK ALL** is selected, press the **CURSOR RIGHT ►** button to turn the control **ON** or **OFF**. When **ON** is selected, ALL available channels will be blocked from viewing.

**3** When finished, press the **STATUS/EXIT** button to remove the menu from the screen.

**NOTE:** If you ever forget your code, the 0, 7, 1, 1 code is the factory default and can be used to enter and create a new access code.

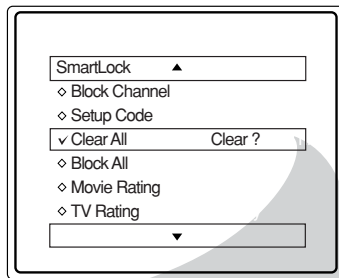

✓ Clear All      Cleared

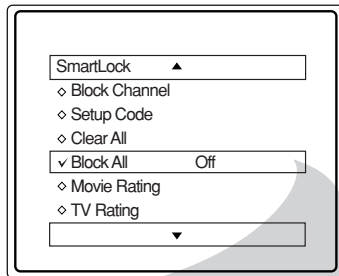

✓ Block All      On

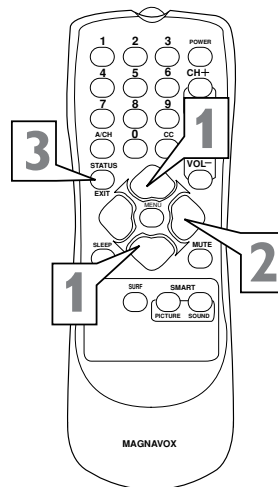

Some models refer to SmartLock as AutoLock in the on-screen menu. These features are the same.

# 18 BLOCKING PROGRAMS BASED ON MOVIE RATINGS

The SmartLock™ feature can block programming based on the Movie Industry ratings.

Once you've entered your access code and the SmartLock™ features are displayed on the screen:

- 1** Press the **CURSOR UP ▲** or **DOWN ▼** buttons to highlight the words **MOVIE RATING**.
- 2** Press the **CURSOR RIGHT ►** button to display the **MOVIE RATING** options (G, PG, PG-13, R, NC17, or X).
- 3** Press the **CURSOR UP ▲** or **DOWN ▼** buttons to highlight any of the Movie Rating options. When highlighted, all these options can be turned **ON** (which will allow blocking) or **OFF** (which will allow viewing).
- 4** Use the **CURSOR RIGHT ►** button on the remote to turn the rating option **ON** or **OFF**.

When a rating level is chosen to be blocked, any higher level rating will also be blocked from viewing. (i.e.: If "R" is selected to be blocked, NC-17 and X will automatically be blocked.)

**NOTE:** If you ever forget your code, the 0, 7, 1, 1 code is the factory default and can be used to enter and create a new access code.

Some models refer to SmartLock as AutoLock in the on-screen menu. These features are the same.

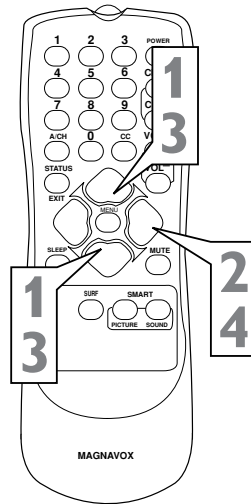
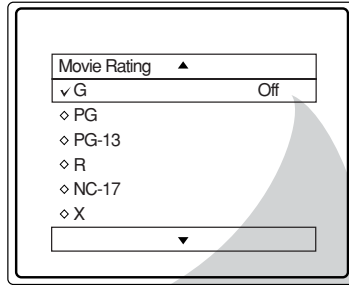
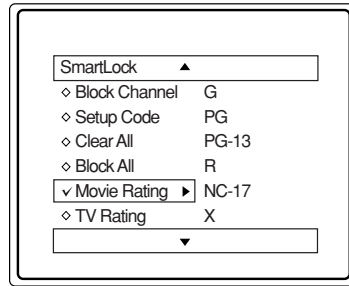

The SmartLock™ feature can block programming based on the TV Industry ratings.

Once you've entered your access code and the SmartLock™ features are displayed on the screen:

- 1 Press the **CURSOR UP ▲** or **DOWN ▼** buttons to highlight the words TV RATING.
- 2 Press the **CURSOR RIGHT ►** button to display the **TV RATING** options (TV-Y, TV-Y7, TV-G, TV-PG, TV-14, or TV-MA).
- 3 Press the **CURSOR UP ▲** or **DOWN ▼** buttons to highlight any of the TV Rating options. When highlighted, all these options can be turned **ON** (which will allow blocking) or **OFF** (which will allow viewing).

**NOTE:** Some TV RATING options also have sub-ratings. The ratings of TV-Y7, TV-PG, TV-14, TV-MA can be customized to block V (violence), FV (fantasy violence), S (sexual situations), L (coarse language), or D (suggestive dialogue).

- 4 Press the **CURSOR RIGHT ►** button on the remote to turn the TV-Y or TV-G rating ON or OFF. Or, press the **CURSOR RIGHT ►** button to enter the sub-menus for the TV-Y7, TV-PG, TV-14 or TV-MA ratings.
- 5 If the TV-Y7, TV-PG, TV-14 or TV-MA sub-menu is accessed, press the **CURSOR UP ▲** or **DOWN ▼** buttons to select one of the options (Block All, V, S, L, D, or FV).
- 6 Press the **CURSOR RIGHT ►** button on the remote to turn the option ON or OFF.

Some models refer to SmartLock as AutoLock in the on-screen menu. These features are the same.

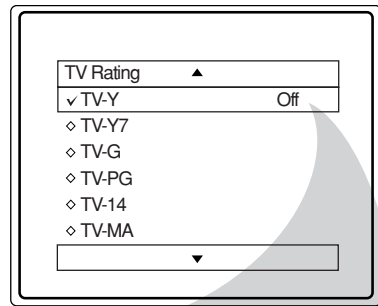

✓ TV-Y On

✓ TV-Y7 ► Block All, FV

✓ TV-G Off

✓ TV-PG ► Block All, V, S, L, D

✓ TV-14 ► Block All, V, S, L, D

✓ TV-MA ► Block All, V, S, L

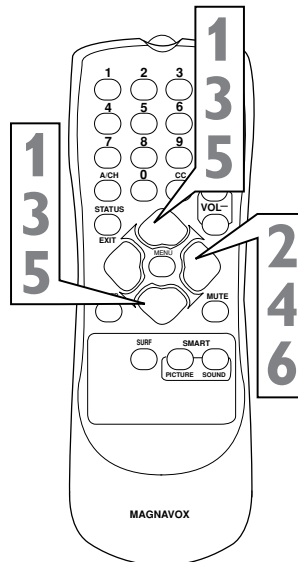

SmartLock™ offers the viewer other blocking features as well. With these Blocking Options, the censoring can be turned ON or OFF.

Once you've entered your access code and the SmartLock™ features are displayed on the screen:

**1** Press the **CURSOR UP ▲** or **DOWN ▼** buttons until the words **BLOCKING OPTIONS** are highlighted.

**2** Press the **CURSOR RIGHT ►** button to display the **Blocking Options (BLOCKING, UNRATED, or NO RATING)** menu.

**BLOCKING:** Might be called the “master switch” for SmartLock™. When ON, ALL blocking/censoring will take place. When OFF, ALL blocking is disabled.

**UNRATED:** ALL unrated programs based on the Movie Ratings or Parental (TV) Guidelines can be blocked if this feature is set to ON and the BLOCKING feature is set to OFF.

**NO RATING:** ALL programming with NO content advisory data can be blocked if set to ON and the BLOCKING feature is set to OFF.

**3** Press the **CURSOR UP ▲** or **DOWN ▼** buttons to highlight the desired feature.

**4** When highlighted, each feature can be turned **ON** or **OFF** using the **CURSOR RIGHT ►** or **LEFT ◀** buttons on the remote.

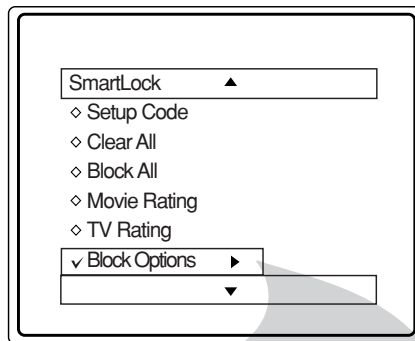

✓ Blocking On

✓ Unrated On

✓ No Rating On

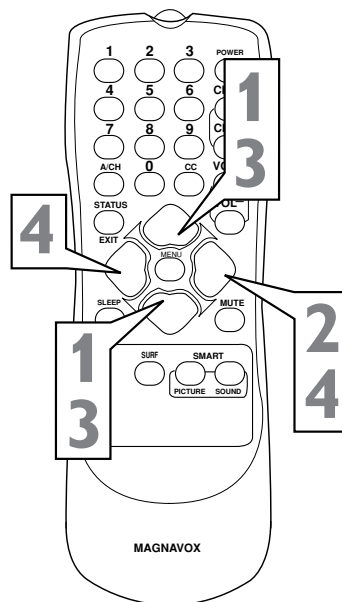

Some models refer to SmartLock as AutoLock in the on-screen menu. These features are the same.



# 21

## HOW TO USE THE CLOSED CAPTION CONTROLS

Closed Captioning (CC) allows you to read the voice content of television programs on the TV screen. Designed to help the hearing impaired, this feature uses on-screen "text boxes" to show dialogue and conversations while the TV program is in progress.

- 1 Press the CC button** on the remote to display the current Closed Caption setting.
- 2 Press the CC button repeatedly** to choose from the four Closed Caption options (CC Off, CC1, CC2, or CC Mute). CC Mute will activate Closed Captioning when the MUTE button is pressed.
- 3 When finished, press the STATUS /EXIT button** to remove the menu from the TV's screen.

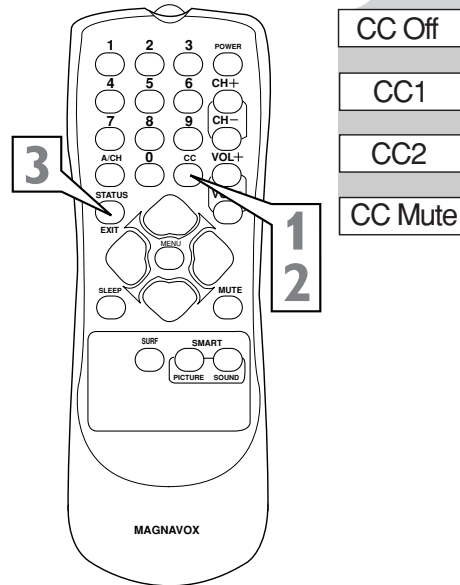
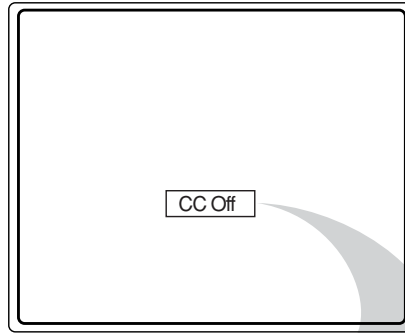

### HELPFUL HINT

**Not all TV programs and product commercials** are made with Closed Caption (CC) information included. Neither are all Closed Caption modes (CC1, or CC2) necessarily being used during the transmission of a closed caption program. Refer to your area's TV program listings for the stations and times of Closed Caption shows.

Your TV can be set to automatically turn itself off at a given amount of time.

1 Press the SLEEP button on the remote control and the SLEEP timer display will appear on the screen.

2 Press the SLEEP button repeatedly to pick the amount of time (15, 30, 45, 60, 90, 120, 180, or 240 minutes) before the TV will turn itself off.

NOTE: An on-screen count down will appear during the last minute before the TV shuts itself off. If any button is pressed during the last minute of the countdown, the Sleptimer setting will be cancelled.

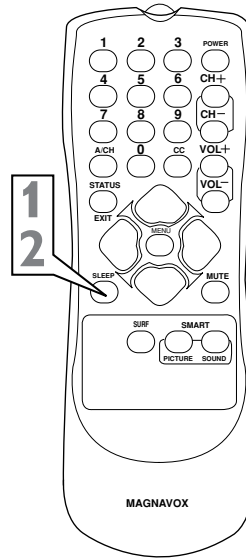
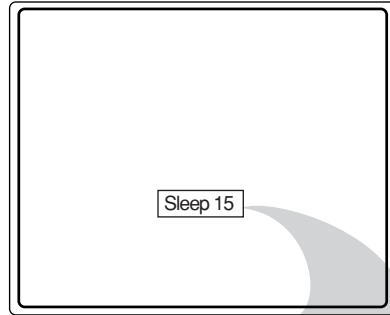

- Sleep 15
- Sleep 30
- Sleep 45
- Sleep 60
- Sleep 90
- Sleep 120
- Sleep 180
- Sleep 240
- Sleep off

During the last 10 seconds of a Sleptimer setting, an on-screen display will read GOOD BYE.

During the last minute of a Sleptimer setting, an on-screen count down will be displayed. Pressing any button during the last minute will cancel the Sleptimer.

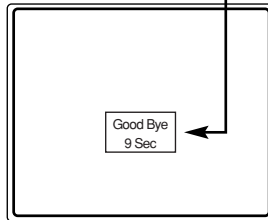
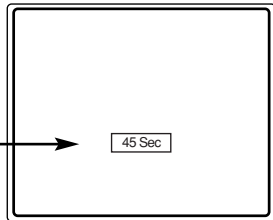

Whether you're watching a movie or a sporting event, your TV has automatic video control settings matched for your current program source or content.

- 1 Press the **SMART PICTURE** button on the remote control. The current Smart Picture setting will be displayed on the screen.
- 2 Press the **SMART PICTURE** button repeatedly to select either **PERSONAL**, **MOVIES**, **SPORTS**, **WEAK SIGNAL**, or **MULTIMEDIA** picture settings.

**NOTE:** The way you choose to set the Picture Menu Controls will become your **PERSONAL** setting.

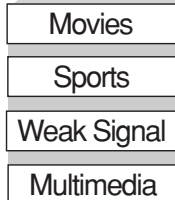
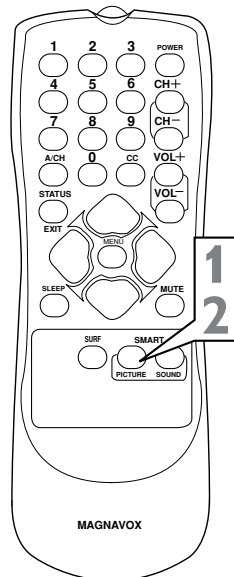
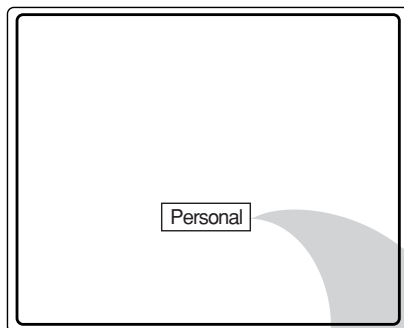

**MOVIES** - Preset picture options for watching Video Tapes, or DVDs.

**SPORTS** - Preset picture options for watching sporting events.

**WEAK SIGNAL** - Preset picture options for watching programs where the reception is not at its best.

**MULTIMEDIA** - Preset picture options for use with video gaming.

The Smart Sound feature allows the listener to select between four different factory set sound options.

- 1 Press the **SMART SOUND** button on the remote control. The current Smart Sound setting will appear in the middle of the screen.
- 2 Press the **SMART SOUND** button repeatedly to toggle between the four settings. (PERSONAL, VOICE, MUSIC, or THEATRE)

**NOTE:** The way you choose to set the Sound Menu Controls will become your PERSONAL setting.

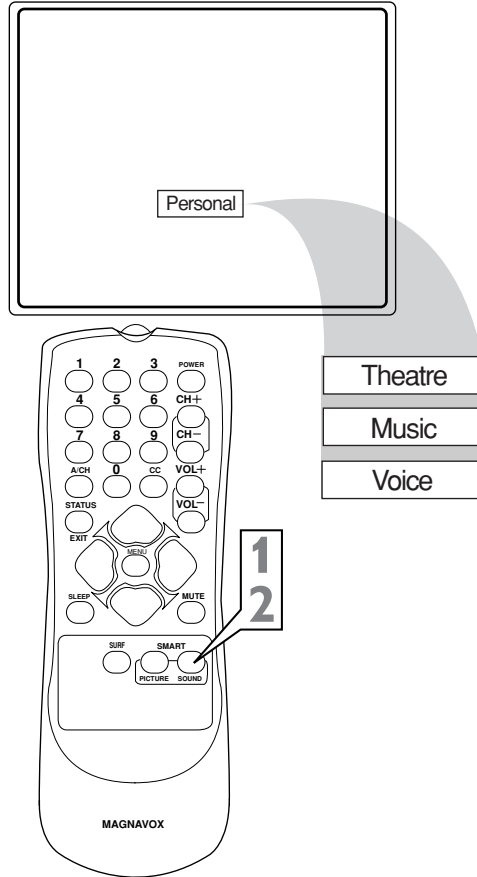

**THEATRE** - Preset sound options for watching movies.

**MUSIC** - Preset sound options for musical programming where there is little or no dialogue.

**VOICE** - Preset sound options for programming where heavy dialogue is present.

SmartSurf lets you set up to eight channels in a quick viewing list. Then, you can use the SURF button on the remote control to switch between different TV programs that currently interest you.

- 1** Press **CH +/-** or the Number buttons to select a channel to add to the SURF list.
- 2** Press **SURF** while the channel number appears.
- 3** Press **▶** or **◀** to add the channel to the SURF list or delete it from the list. An on-screen message will indicate whether you are adding or deleting the channel. Repeat steps 1 through 3 to add additional channels (up to eight) to the SURF list.

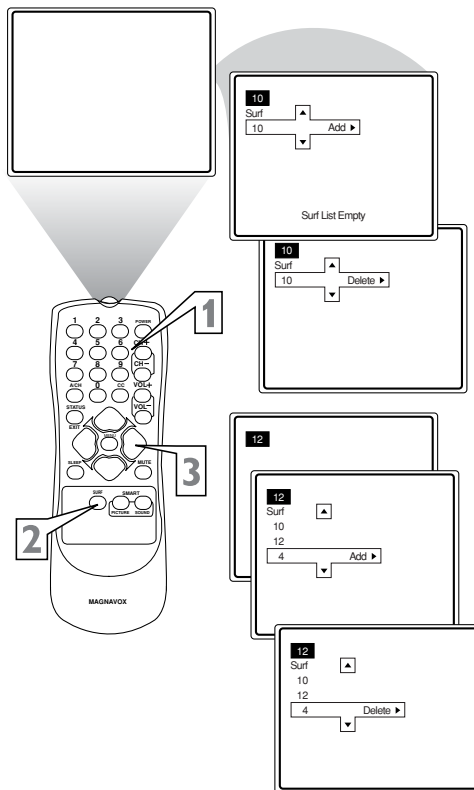

Press SURF repeatedly during TV viewing to scan through the channels in the SURF list.

Your remote control has an Alternate Channel button that allows you to toggle between the current and previous channel. For instance, if you are watching two games on TV, you can enter the channel numbers once and flip between the two channels with the touch of only one button.

After entering the two channels numbers, so that one is the last viewed channel and the other is the current channel, follow the step below.

- 1 Press the A/CH button** on the remote control. The channels will toggle between the current channel and the last viewed channel.

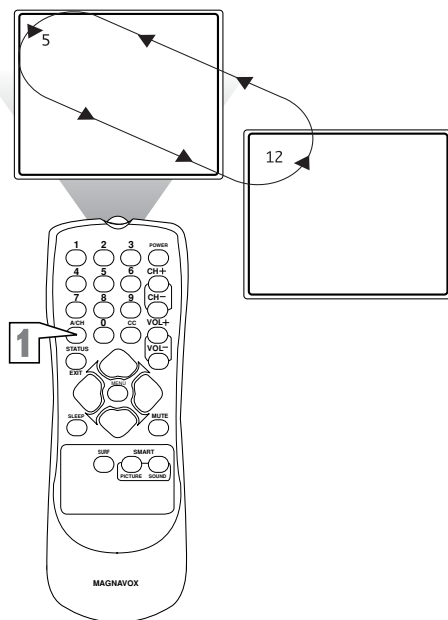

**No Power**

- Check the TV power cord. Unplug the TV, wait 10 seconds, then reinsert the plug into the outlet and push the POWER button again.
- Check that the outlet is not on a wall switch.
- Be sure the fuse is not blown on the AC power strip, if one is being used.

**No Picture**

- Check antenna connections. Are they properly secured to the TV's ANT 75Ω plug?
- Check the TUNER MODE control for the correct tuner setting.
- Try running the Auto Program feature to find all available channels.
- Press the CH+ or CH- buttons on the remote to make sure the correct signal source is selected (FRONT or Current Channel).

**No Sound**

- Check the VOLUME buttons.
- Check the MUTE button on the remote control.
- If you're attempting to hook up auxiliary equipment, check the audio jack connections located on the front of the TV.

**Remote Does Not Work**

- Check the batteries. If necessary, replace them with 2 AA Heavy Duty (Zinc Chloride) or Alkaline batteries.
- Clean the remote control and the remote control sensor window on the TV.
- Check the TV power cord. Unplug the TV, wait 10 seconds, then reinsert the plug into the outlet and push the POWER button again.
- Be sure the fuse is not blown on the AC power strip, if one is being used.
- Check to be sure the TV outlet is not on a wall switch.

**TV Displays Wrong Channel or No Channels Above 13**

- Repeat channel selection.
- Add the desired channel numbers (using the CHANNEL EDIT control) into the TV's memory.
- Check to be sure the TUNER MODES are set to the CABLE option and run the Auto Program feature to find all available channels.

**WARNING Concerning Stationary Images on the TV Screen:**

**Do not leave stationary or letterbox images on screen for extended periods of time. This can cause uneven picture-tube aging.**

Normal use of the TV should involve the showing of pictures that contain constantly moving and changing images that fill the screen. Be careful not to leave nonmoving images on screen for extended periods of time, or to display the same images on screen too frequently, because subtle ghost images can be left on the picture tubes. Sources of stationary images may be DVD disks, laser disks, video games, CD-i disks, videotapes, digital television boxes, broadcast channels, cable channels, satellite channels, and others. **Here are some examples of stationary images (this is not an all-inclusive list; you may encounter others in your viewing):**

- **DVD menus**—listings of DVD disk content
- **Letterbox black bars**—shown at the top and bottom of the TV screen when a wide screen (16:9) movie is viewed on a TV with standard (4:3) aspect ratio.
- **Video-game images and scoreboards**
- **Television station logos**—present a problem if they are bright and stationary; moving or low-contrast graphics are less likely to cause uneven aging of the picture tube
- **Stock-market tickers**—presented at the bottom of the TV screen
- **Shopping channel logos and pricing displays**—bright and shown constantly or repeatedly in the same location on the TV screen.

**PLACEMENT OF THE TV**

- To avoid cabinet warping, cabinet color changes, and increased chance of set failure, do not place the TV where temperatures can become excessively hot; for example, in direct sunlight or near a heating appliance.
- Be sure to allow a free flow of air to and from the perforated back cover of the set.

**CLEANING**

- To avoid possible shock hazard, be sure the TV is unplugged from the electrical outlet before cleaning.
- Regularly dust the TV with a dry, non-scratching duster to keep the TV clean.
- When cleaning the TV, take care not to scratch or damage the screen surface. Avoid wearing jewelry or using anything abrasive. Do not use household cleaners. Wipe the front screen with a clean cloth dampened with water. Use even, easy, vertical strokes when cleaning.
- Gently wipe the cabinet surfaces with a clean cloth or sponge dampened in a solution of cool, clear water and a mild soap or detergent. Use a clean, dry cloth to dry the wiped surfaces.
- Occasionally vacuum the ventilation holes or slots in the back cover of the set.
- Never use thinners, insecticide sprays, or other chemicals on or near the cabinet, as they might cause permanent marring of the cabinet finish.



**Auto Programming** • The procedure of adding or deleting channel numbers into the Television's memory circuits. In this format the Television "remembers" only the locally available or desired channel numbers and skips over any unwanted channel numbers.

**Coaxial Cable** • A single solid antenna wire normally matched with a metal plug (F-type) end connector that screws (or pushes) directly onto a 75 Ohm input found on the Television or VCR.

**Closed Caption** • Broadcast standard which allows you to read the voice content of television programs on the TV screen. Designed to help the hearing impaired this feature uses on-screen "text boxes" to show dialogue and conversations while the TV program is in progress.

**Side Audio/Video Inputs** • Located on the side of the TV these connectors (phono type plug) are used for the input of audio and video signals. Designed for easy use with VCRs or cameras.

**On Screen Displays (OSD)** • Refers to the wording or messages generated by the television (or VCR) to help the user with specific feature controls (color adjustment, programming, etc.).

**Menu** • An on-screen listing of feature controls shown on the Television screen that are made available for user adjustments.

**Remote Sensor Window** • A window or opening found on the Television control panel through which infrared remote control command signals are received.

**Status/Exit** • Allows the user to quickly confirm what channel number is currently being viewed. Status can also be used to clear the Television of on screen displays or information (rather than waiting for the displays to "time out" or automatically disappear from the screen).

**Surf** • The action of scanning specific channel in a limited channel list.

**Twin Lead Wire** • The more commonly used name for the two strand 300 Ohm antenna wire used with many indoor and outdoor antenna systems. In many cases this type of antenna wire requires an additional adapter (or balun) in order to connect to the 75 Ohm Input terminals designed into the more recent Televisions and VCRs.

**Tuner Mode** • Feature control settings made by the TV. Designed for first time set up and use. Settings for signal connections (antenna or cable TV), plus channel program memory are held in the TV's memory (even if the set is unplugged and moved to a new location.)





## MAGNAVOX LIMITED WARRANTY

### Ninety (90) Days Labor & One (1) Year Parts & One (1) Year Display

**MAGNAVOX** warrants this product against defect in material or workmanship, subject to any conditions set forth as follows:

**PROOF OF PURCHASE:**

You must have proof of the date of purchase to receive warranted repair on the product. A sales receipt or other document showing the product and the date that you purchased the product as well as the authorized retailer included, is considered such proof.

**COVERAGE:**

(If this product is determined to be defective)  
**LABOR:** For a period of ninety (90) days from the date of purchase, Magnavox will repair or replace the product, at its option, at no charge, or pay the labor charges to any Magnavox authorized service center. After the period of ninety (90) days, Magnavox will no longer be responsible for charges incurred.

**PARTS:** For a period of one (1) year, Magnavox will supply, at no charge, new or rebuilt replacement parts in exchange for defective parts. Magnavox authorized service centers will provide removal and installation of the parts under the specified labor warranty.

**DISPLAY:** For a period of one (1) year from the date of purchase, Magnavox will supply, at no charge, a new or rebuilt active display device in exchange for the defective display. Magnavox authorized service centers will provide removal and installation of the parts under the specified labor warranty. (PTV screens carry a thirty (30) day replacement warranty.)

**EXCLUDED FROM WARRANTY COVERAGE**

Your warranty does not cover:

- Labor charges for installation or setup of the product, adjustment of customer controls on the product, and installation or repair of antenna systems outside of the product.
- Product repair and/or part replacement because of improper installation, connections to improper voltage supply, abuse, neglect, misuse, accident, unauthorized repair or other cause not within the control of Magnavox.

*This warranty gives you specific legal rights. You may have other rights which vary from state/province to state/province.*

- A product that requires modification or adaptation to enable it to operate in any country other than the country for which it was designed, manufactured, approved and/or authorized, or repair of products damaged by these modifications.
- Damage occurring to product during shipping when improperly packaged or cost of associated packaging.
- Product lost in shipment and no signature verification of receipt can be provided.
- A product used for commercial or institutional purposes (including but not limited to rental purposes).
- Products sold AS IS or RENEWED.

**TO OBTAIN WARRANTY SERVICE IN THE U.S.A., PUERTO RICO, OR U.S. VIRGIN ISLANDS...**

Contact Magnavox Customer Care Center at

1-800-705-2000

**TO OBTAIN WARRANTY SERVICE IN CANADA...**

1-800-661-6162 (French Speaking)

1-800-705-2000 (English or Spanish Speaking)

REPAIR OR REPLACEMENT AS PROVIDED UNDER THIS WARRANTY IS THE EXCLUSIVE REMEDY FOR THE CONSUMER. MAGNAVOX SHALL NOT BE LIABLE FOR ANY INCIDENTAL OR CONSEQUENTIAL DAMAGES FOR BREACH OF ANY EXPRESS OR IMPLIED WARRANTY ON THIS PRODUCT. EXCEPT TO THE EXTENT PROHIBITED BY APPLICABLE LAW, ANY IMPLIED WARRANTY OF MERCHANTABILITY OR FITNESS FOR A PARTICULAR PURPOSE ON THIS PRODUCT IS LIMITED IN DURATION TO THE DURATION OF THIS WARRANTY.

Some states do not allow the exclusions or limitation of incidental or consequential damages, or allow limitations on how long an implied warranty lasts, so the above limitations or exclusions may not apply to you. In addition, if you enter into a service contract agreement with the MAGNAVOX partnership within ninety (90) days of the date of sale, the limitation on how long an implied warranty lasts does not apply.

**Magnavox, P.O. Box 671539, Marietta, GA. 30006-0026**

(Warranty: 4835 710 28125)